



- Triple-glazed door
- Suitable for multiple flue connections
- Inner lining (refractory lining) can be replaced through the fire door
- Equipped with 2 transportation wheels at the back for easy installation.
- For extensive and wise accessory see price list

SH 9 D Wood firing

Specifications

Rated thermal output	kW	9
Output range (depending on the fuel quantity)	kW	3,4 - 9,5
Efficiency	%	82,2
Insulation rear / side walls	mm	80 / 80
Ø Supply air line for external air connection	mm	---
Weight incl. refractories	kg	220
Heat emission through glass	%	10
Convective heat	%	90

Data for chimney sweepers or responsible authority according to DIN EN 13384

Closed operation: A1

Triple value for NWL	Flue gas mass flow	g/s	8,9
	Flue gas temperature downstream of reheater element	°C	270
	Required draught at flue gas connector	mbar	0,12
Triple value for calculation of the ceramic channels	Wood quantity	kg/h	4,2
	*Firing power	kW	13,6
	*Flue gas mass flow	g/s	18,2
	*Flue gas temperature before the secondary unit area	°C	529
	*Necessary conveying pressure at the flue gas connector	mbar	0,15
*Combustion air requirements	m³/h	42,8	

* in relation to the wood quantity

Optional comfort features



Outside air connector



SMS - Mini



SMS



Tube door



Water technology



Reheater box



Ceramic flue heat exchanger

Tested method DIN EN 13229
and in accordance with Regulation Art. 15a B-VG

Testing report nr.: RRF - 29 07 1107



1. BlmSchV. level 1



1. BlmSchV. level 2



More informations:

SH 9 D

Wood firing

Front view M 1:20

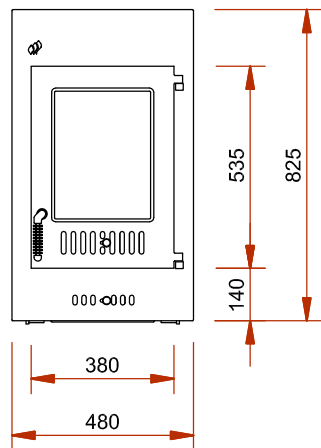

Side view M 1:20

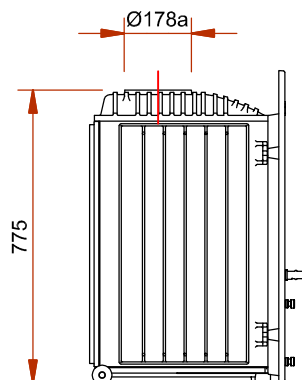

Top view M 1:10

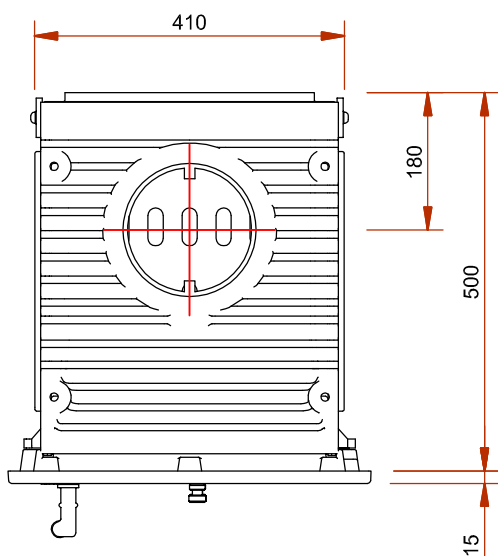

Inner lining

